

Website: <http://www.embedia.com>

Email: [support@embedia.com](mailto:support@embedia.com)

Phone: +1-403-456-6279

## GROUP-M2-PC-B



2-Motor Wired MS/TP Group Motor Controller  
in Customized Plastic Enclosure

## Package Contents

- 1 x 2-Motor Wired MS/TP Group Motor Controller in Customized Plastic Enclosure with the following removable components:
  - 3 x Pluggable Switch Terminal Block
  - 2 x Pluggable MS/TP Network Terminal Block
  - 3 x Hirschmann STASI-3 Safety Bracket Clip

## Overview

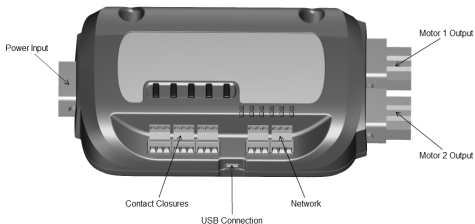

## Group Functionality

When multiple Group Motor Controllers are networked together, motors can be operated in configurable groups. Typical usage of these controllers is to group motors as follows:

1. Blackout and Sheer Shades
2. By Façade
3. By Room

Switches are typically used to control the defined groups with various USB add-ons that can be added to provide additional functionality. 1, 2, and 4-Motor controllers are available.

## Before You Begin

---

You will need the following tools and accessories:

- 2 x #10 Wood or Concrete Screws and matching screwdriver for mounting
- 1 x Hirschmann STAK-3N Power Plug
- 2 x Hirschmann STAS-3N Motor Plugs
- Wire Stripper
- 3-Wire Line Voltage Cable (Max 12 AWG) for Power
- 4-Wire Line Voltage Cable (Max 12 AWG) for Motor
- Optional
  - Precision Screwdriver for Switch and Network terminations
  - 3-Wire Low Voltage Cable (Max 16 AWG) for Contact Closure (CAT 5 will work)
  - 1-Twisted Pair + Ground Cable (Max 16 AWG) for Network (CAT 5 will work)
  - USBIF-WiFi Add-on and Embedia InSight App for Advanced Programming
  - One of the other available USBIF Add-ons for added functionality

## Mounting Details

---

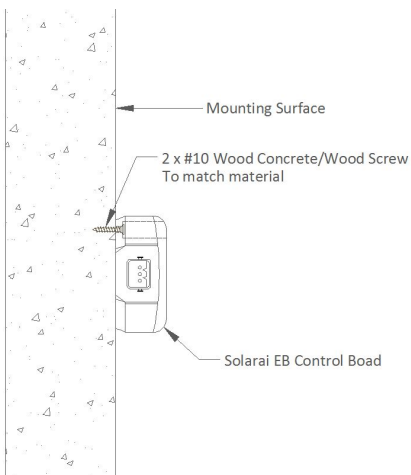

# Wiring Details

**⚠ All wiring and connections should be completed by licensed electricians, in compliance with Local and State Code**

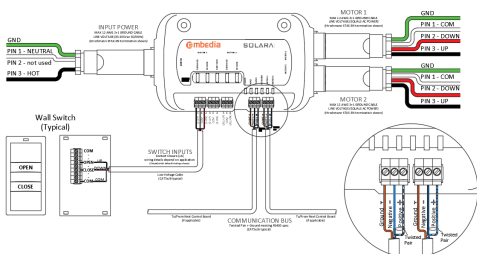

**⚠ IMPORTANT:** Motor wiring (as drawn) assumes ALL motors are mounted in a "left-hand" or "right-hand" configuration which determines the direction of rotation when power is applied to each of the directional wires. When both configurations are used, the "UP" and "DOWN" wires may need to be swapped for individual motor outputs in order for the motors to operate synchronously in the same direction. Wiring should be verified using the onboard buttons. All motors should operate in the same direction when operated from the onboard buttons.

## MS/TP Network Wiring (Optional)

MS/TP is an industry-standard protocol based on the EIA-485 (RS-485) physical specification under the BACnet™ standard (*BACnet™ is a trademark of ASHRAE.*).

According to the standard:

An MS/TP EIA-485 network shall use shielded, twisted-pair cable for data signaling with characteristic impedance between 100 and 130 ohms. Distributed capacitance between conductors shall be less than 100 pF per meter (30 pF per foot). Distributed capacitance between conductors and shield shall be less than 200 pF per meter (60 pF per foot). Foil or braided shields are acceptable.

Standard CAT-5 or above network cable meets this specification.

The EIA-485 transceiver used in this controller is a 1/8th Unit-Load device which allows 127 controllers to be connected together in a single chain.

The network terminal blocks can be unplugged from the board for ease of wiring. Ensure that a "twisted-pair" is used between the positive and negative terminals, otherwise communication problems may occur. A completely wired network should look like a single chain of devices with no "T" junctions or circular loops.

## USB Add-on Wiring (Optional)

When plugging in a USB Add-on, ensure that the Micro-A (rectangular-shaped) host end of the cable is plugged into the controller. The Micro-B (trapezoidal-shaped) device end of the cable will fit into the controller's receptacle, but the unconnected end will not fit into the Add-on's receptacle.

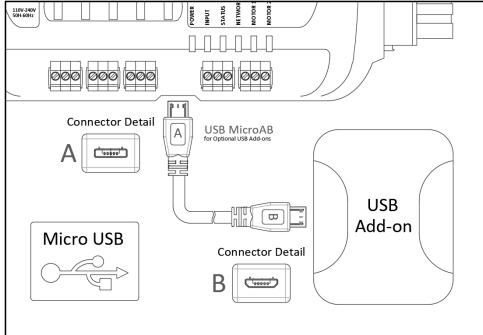

## Default Switch Operation

**Out-of-the-Box**, the 6 onboard contact closure (dry contact) inputs are set up to allow three (3) two-button contact closure (dry contact) switches to control all motors, motors 1 and 3, and motors 2 and 4, respectively, on any controllers that have those numbered motor outputs connected on the same network.

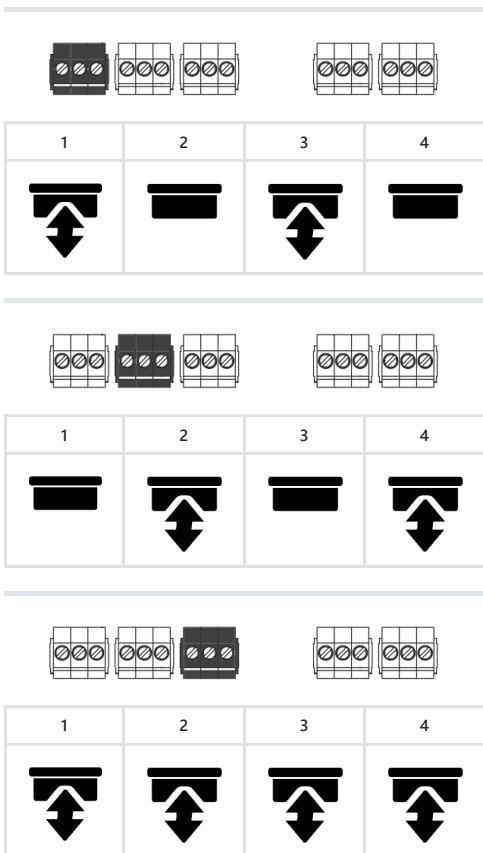

Closing a contact momentarily will start the motors moving in the corresponding direction. Closing both contacts will stop the motors.

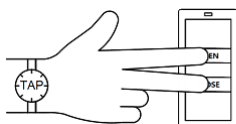
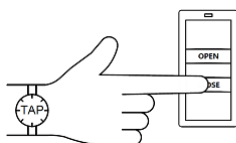
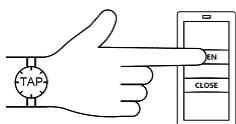

Holding a contact closed for more than 1.5 seconds will move the motors in the corresponding direction until the contact is released.

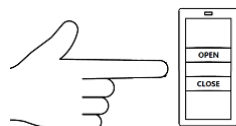
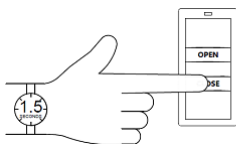
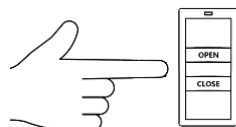

The onboard contact closure (dry contact) input(s) can be reconfigured to control any number of motors on the connected network using the Embedia InSight App (free download) in conjunction with the USBIF-WiFi Add-on (sold separately) plugged into the onboard USB port of any controller on the connected network. Contacts can also be regrouped to provide more advanced functionality like scenes.

## USBIF-WiFi Add-on











## Embedia InSight App



Android	iOS
	

## LED Indicators

Indicator	Indication
 Solid Blue LED	Controller is powered
 Solid Green Motor LED	Motor is operating forward
 Solid Red Motor LED	Motor is operating reverse
 Fast Blinking Amber Network LED	Controller is attempting to communicate with other controllers on the network
 Solid Amber Network LED	Controller is communicating with other controllers on the network
 Solid Amber Switch LED	Contact Closure (Dry Contact) Input is closed
 Solid Red Status LED	Either:  1) Controller is waiting for a firmware upgrade file, or  2) The motor controller stopped actuating the motor due to an abnormal current spike.
 Blinking Red Status LED	Controller is processing a firmware upgrade file

## Technical Specifications

Parameter	Specifications
Line Voltage Input	Universal 110-240 VAC at 50-60 Hz
Motor Outputs	2 Motor Outputs; 110-240 VAC (Matched to Line Voltage Input); Max. 10A
Low Voltage Inputs	6 Contact Closure Inputs (3 pairs); Default: Up/Down for motors (channels 1 and 3, channels 2 and 4, and all channels)
Communication Network (optional)	BACnet / MSTP; Maximum 127 Devices per Segment; Expandable using BACnet IP Routers such as ControlPoint-IP
Network Wiring (optional)	1 x Twisted Pair + Ground suitable for RS485 Communication; 1200m / 4000ft absolute max bus Length (limiting to 600m / 2000ft recommended)



